

MDH Series Air Dryer

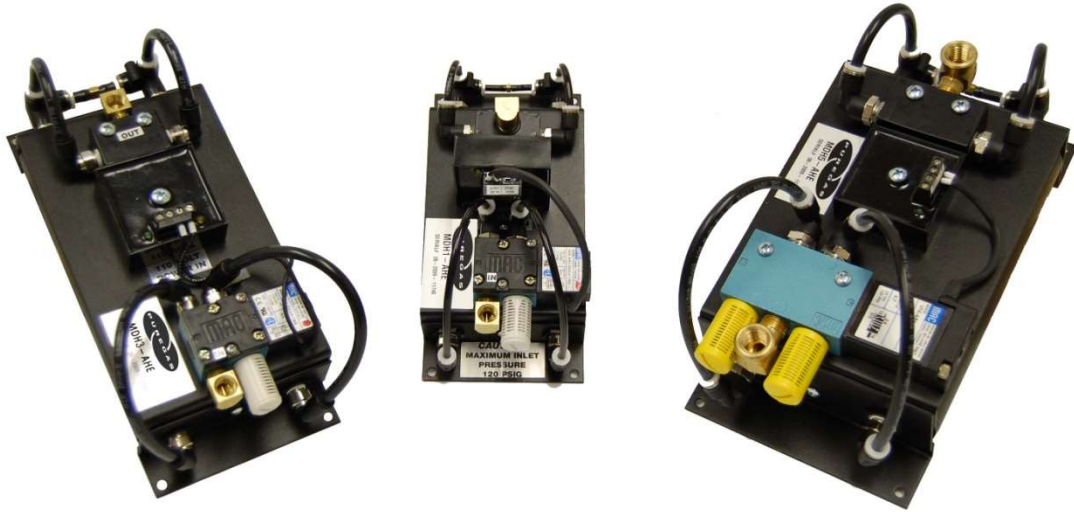

User's Guide

Models covered:

MDH1 MDH2 MDH3 MDH4 MDH5 MDH6





WARNING:

This product can expose you to chemicals including Lead, which is known to the State of California to cause cancer/birth defects or other reproductive harm. For more information go to www.P65Warnings.ca.gov

1. Welcome & Congratulations

Congratulations on your purchase of a new ALTEC AIR MDH SERIES AIR DRYER! We here at ALTEC AIR are very proud of our products. We are committed to providing you with the best value and service possible.

We are sure that you will be satisfied with your new unit and would like to thank you for choosing ALTEC AIR for your air dryer requirements. We also hope that you will continue to choose us for your future Compressed Air Treatment and related products purchases.

For information about this and other ALTEC AIR products, please visit us on the web at

www.AltecAIR.com

2. Introduction

PLEASE READ THIS USER'S GUIDE THOROUGHLY AND SAVE FOR FUTURE REFERENCE.

This User's Guide is provided for the benefit of our customers and contains information and direction specific to the ALTEC AIR MDH SERIES AIR DRYER. It will cover topics including: safety, specifications, installation, testing, maintenance, and troubleshooting issues. Observation and compliance with this User's Guide will ensure the maximum life and efficiency of your air dryer.

This User's Guide should be read thoroughly prior to installing, operating, or servicing the air dryer in order to become familiar with the recommended procedures. This will minimize the possibility of personal injury or damage to the dryer due to improper operation or handling.

3. Table of Contents

1. Welcome & Congratulations	3	10. Replacement Parts & Accessories	25
2. Introduction	3	10.1 Parts	25
3. Table of Contents.....	4	10.2 Parts Continued.....	26
4. Safety & Warning Information	5	10.3 Accessories for Your Air Dryer.....	27
5. Overview & Specifications.....	6	10.4 Ordering Parts from ALTEC AIR.....	28
5.1 Product Description	6	11. Service & Repair.....	28
5.2 Key Features.....	6	11.1 Services Offered at Altec AIR' Facility..	28
5.3 MDH Series Air Dryer Models.....	6	11.2 Initiating a Service Transaction	29
5.4 Technical Specifications.....	7	12. Troubleshooting Your Air Dryer	29
6. Installing Your Air Dryer	8	12.1 Before You Call ALTEC AIR	29
6.1 Safety & Warning Information	8	12.2 Safety & Warning Information	30
6.2 Before You Begin.....	9	12.3 Restricted Pressure or Flow	30
6.3 Included Contents.....	10	12.4 Excessive Purge.....	31
6.4 Required Tools and Materials.....	10	12.5 Delivers Wet Air.....	31
6.5 Installation Steps.....	11	12.6 Contacting ALTEC AIR Technical	
6.6 Installation Checklist	14	Support.....	32
7. Registering Your MDH Series Air Dryer	15	13. Appendix	33
8. Testing Your Air Dryer.....	16	13.1 Model Number Coding	33
8.1 Safety & Warning Information	16	13.2 Wiring Diagram	33
8.2 Testing Consistent Dryer Cycling.....	17	14. Limited Warranty Agreement.....	34
8.3 Measuring Incoming Voltage	18	Registration Reminder	34
8.4 Measuring 4 Way Solenoid Voltage.....	19	15. Contacting ALTEC AIR	35
8.5 Visually Verify Cycle Timer	20	15.1 General.....	35
8.6 Test for Purge Muffler Restriction.....	21	15.2 Sales.....	35
8.7 Testing Air Fittings & Hoses for Leaks....	22	15.3 Service	35
9. Maintaining Your Dryer	23	15.4 Technical Support.....	35
9.1 Safety & Warning Information	23	16. Maintenance Log Sheet	36
9.2 Maintenance Log Sheet	24	17. Notes.....	36

4. Safety & Warning Information

This section contains general information about safety and warning points to consider and adhere to during installation and maintenance of your air dryer. PLEASE READ THIS SECTION BEFORE PERFORMING ANY OPERATION OR PROCEDURE ON YOUR AIR DRYER.

Additional warnings specific to an operation or procedure will also be presented throughout the following sections. These will include the  symbol as well as a label of “**WARNING!**”, “**CAUTION!**”, or “**IMPORTANT!**”. Please be sure to pay close attention for these warnings and read them as you encounter them.



IMPORTANT!

Performing procedures not described in this User's Guide MAY VOID THE WARRANTY.



IMPORTANT!

Appropriate inlet filtration is **MANDATORY** and outlet filtration is recommended for all applications.



IMPORTANT!

Each air dryer is sized for specific operating conditions. For **OPTIMUM** performance, the maximum available operating pressure should be maintained across the unit. Any pressure reduction or flow control should be done downstream of the unit. Depending on the magnitude of the change, the size of the desiccant chambers or orifice may need to be changed.

5. Overview & Specifications

5.1 Product Description

The MDH SERIES AIR DRYER from ALTEC AIR is a compact, regenerative desiccant air dryer designed to dry compressed air to a standard pressure dew point (PDP) of -40°F. Optional performance of -100°F atmospheric dew point (ADP) can be achieved. The pressure-swing adsorption (PSA) process used is fully automatic and will remain consistent with minimal required periodic maintenance.

5.2 Key Features

- Ultra dry air to better than -40°F PDP
- Continuous self-regenerative operation
- Outlet flow capacities of 0.3 to 2.4 SCFM at 100 PSIG
- Operating pressures of 30 to 120 PSIG
- Miniature design sized for fractional horsepower air compressor
- Low power requirements (6 watts)
- Ideal for OEM and point-of-use applications

5.3 MDH Series Air Dryer Models

Model	Inlet Flow	Purge Flow	Outlet Flow
MDH1	0.40	0.10	0.30
MDH2	0.80	0.20	0.60
MDH3	1.10	0.27	0.83
MDH4	1.60	0.40	1.20
MDH5	2.40	0.60	1.80
MDH6	3.20	0.80	2.40

Notes:

1. Flow capacities in SCFM shown are for standard units operated at 100 PSIG and outlet dew point of -40°F PDP.
2. Inlet and outlet flow capacities will be greater at higher pressures and lower at lower pressures. Consult factory for other conditions.
3. Standard compressed air inlet conditions are 100°F saturated.

5.4 Technical Specifications

Dimensions	MDH1 7.0" H x 3.5" W x 3.3" D MDH2 10.3" H x 3.5" W x 3.3" D MDH3 8.8" H x 4.0" W x 3.5" D MDH4 10.1" H x 4.0" W x 3.5" D MDH5 9.5" H x 5.0" W x 3.8" D MDH6 11.5" H x 5.0" W x 3.8" D
Voltage Requirements	115 VAC, 1 Phase 50/60 Hz 230 VAC, 1 Phase 50/60 Hz 12 VDC 24 VDC 48 VDC
Power	6 Watts
Electrical Rating	NEMA 1
Operating Ambient Temperature Range	33° to 120° F (0.5° to 49° C)
Inlet Temperature	≤ 70°F Recommended 120°F Maximum
Maximum Inlet Pressure	120 PSIG
Cycle Timer	Solid State with memory
Purge Cycle	60 seconds per side continuous
Separation Media	4A50 Molecular Sieve
Noise Level	<90 dBA
Inlet/Outlet Connections	MDH1-MDH4 1/8" NPT Female MDH5-MDH6 1/4" NPT Female

6. Installing Your Air Dryer

6.1 Safety & Warning Information



WARNING!

Extreme care should be exercised to avoid contact with live electrical circuits. Many procedures performed during installation, and testing of this air dryer require the equipment to be running, creating a situation for potential electrical shock. It is highly recommended that you remove all jewelry before performing any procedures.



CAUTION!

Proper Installation & Maintenance as outlined in this User's Guide is extremely important to ensure the reliability and longevity of the equipment as well as prevent damage or personal injury.



CAUTION!

Incoming power to dryer must be one of the following:

- 115 VAC, 1 Phase, 50/60 Hz
- 230 VAC, 1 Phase, 50/60 Hz
- 12 VDC
- 24 VDC
- 48 VDC



CAUTION!

Do **NOT** exceed the SCFM flow capacity of the air dryer. Be aware of what your unit is rated for before installation.

6.2 Before You Begin

6.2.1 Carefully inspect the unit, including the shipping box as well as the air dryer, for ANY DAMAGE CAUSED BY SHIPPING. If any shipping damage is detected, it is important to file a claim with the shipping company prior to continuing the installation procedures.

6.2.2 Read the entire *Installing Your Air Dryer* section to familiarize yourself with the components and procedures before performing the installation.

6.2.3 Verify the installation location of the air dryer:

6.2.3.1 Ambient temperature is between 33° and 120°F

NOTE: Temperatures above 120°F will decrease component lifespan.

6.2.3.2 Meets one of the following power requirements:

- 115 VAC, 1 Phase, 50/60 Hz
- 230 VAC, 1 Phase, 50/60 Hz
- 12 VDC
- 24 VDC
- 48 VDC

6.3 Included Contents

- (1) MDH Series Air Dryer
- (1) User's Guide (not shown)



6.4 Required Tools and Materials

- Power Cord (varies on voltage of unit)
- Needle nose pliers
- Mounting hardware
- Drill
- Drill bit (varies on mounting hardware)
- Medium adjustable wrench (used only when installing a Complete System)
- Small flathead screwdriver
- Cup of soapy water
- 1-inch paint brush (recommended)

6.5 Installation Steps



IMPORTANT!

To properly operate the Air Dryer, ALTEC AIR recommends that all air filtration elements and options be installed. **SEE SECTION 10.3**

6.5.1 Remove the air dryer from packaging.

6.5.2 Check for loose parts or wiring.

NOTE: If ANY SHIPPING DAMAGE is detected, file a claim with the shipping company prior to continuing the installation procedures.

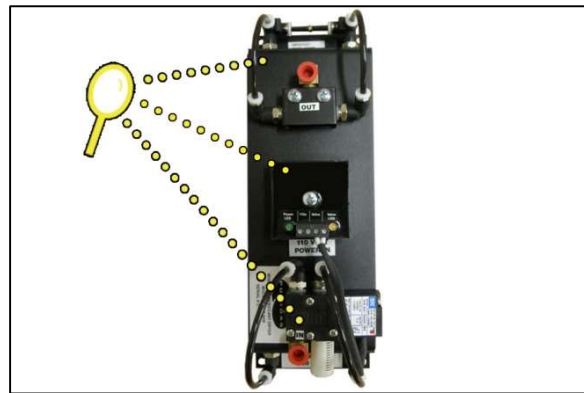

6.5.3 Place the air dryer in the operating location.

6.5.4 With needle nose pliers remove and discard plugs.

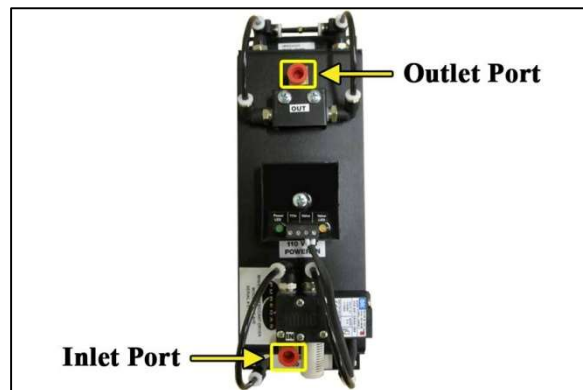

6.5.5 Install inlet and outlet fittings, filters, and/or assemblies to air dryer.

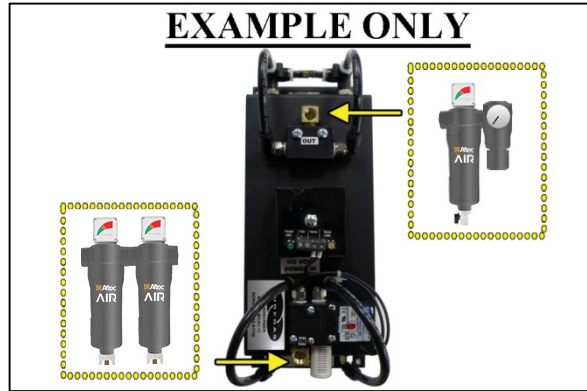

6.5.6 Pre-drill holes in wall, and install wall mount hardware. (See chart below)

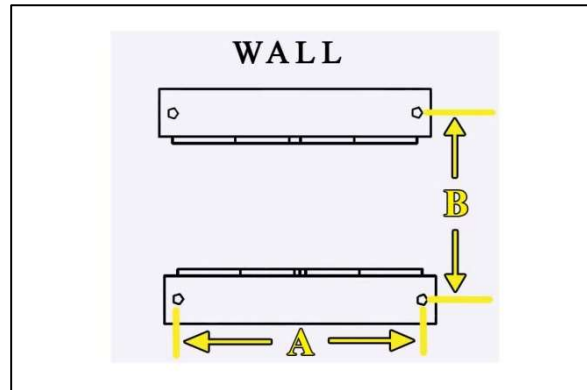

NOTE: Wall mounting hardware installation instructions may vary. The MDH Model will determine the layout for your mounting.

Model	Width (A) x Height (B)
MDH1	3 1/8" x 6 5/8"
MDH2	3 1/8" x 9 7/8"
MDH3	3 5/8" x 8 3/8"
MDH4	3 5/8" x 9 5/8"
MDH5	4 1/2" x 9"
MDH6	4 1/2" x 10 15/16"

6.5.7 Mount MDH to wall using secure wall mounting hardware.

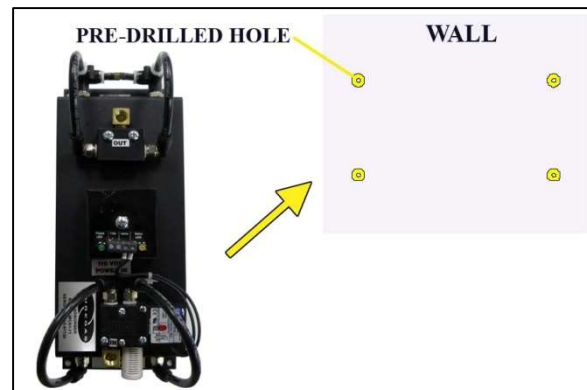

- 6.5.8** Connect the air lines to the inlet and outlet ports.

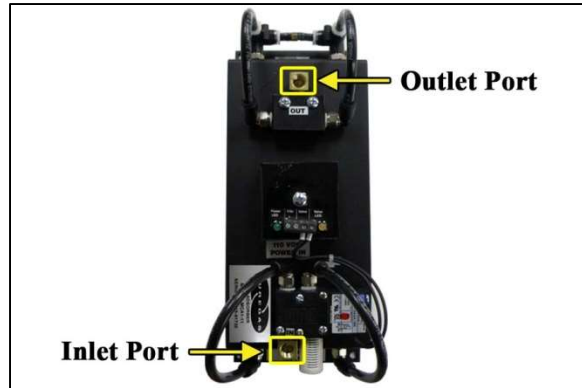

⚠ CAUTION: Do not exceed SCFM flow capacity of the air dryer.

- 6.5.9** With a small flathead screw driver, wire power cord to timer. (DC models have quick connects)

NOTE: Customer must supply a power cord and plug to match their receptacle.



- 6.5.10** Plug in the Power Cord to an outlet:

- 115VAC power outlet, 1 Phase.
- 230 VAC power outlet, 1 Phase.
- 12 VDC power outlet
- 24 VDC power outlet
- 48 VDC power outlet
(VDC outlets not shown)

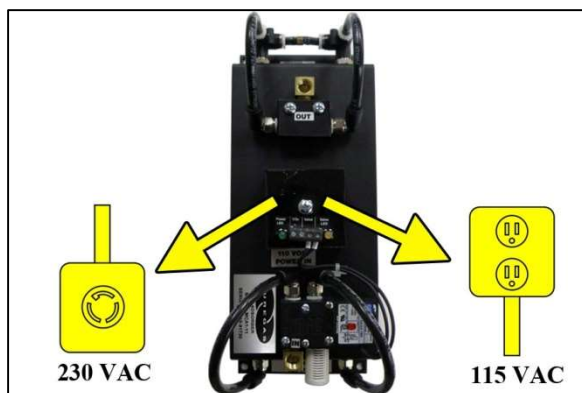

6.5.11 Check for air leaks:

NOTE: This is a general procedure that can be applied to any fitting or hose that has air pressure in it.

6.5.11.1 Listen for any 'hissing' sounds which may indicate a fitting or hose air leak.

6.5.11.2 Use a 1-inch paint brush to dab soapy water on the air fitting or hose connection to be tested.

If air bubbles appear at the connection, this indicates that air is leaking from the connection.



If any leaks are detected, take steps to seal them off (as necessary):

- *Tighten the fitting*
- *Re-connect the hose end*
- *Replace the fitting/hose/component*

6.5.12 REGISTER YOUR AIR DRYER. *See section 7. for details.*

6.6 Installation Checklist

- No shipping damage was detected.
- Wall mounted properly.
- No air leaks are present.

7. Registering Your MDH Series Air Dryer

Please take a moment to register your ALTEC AIR MDH SERIES AIR DRYER. Registering is necessary to activate the Limited Warranty on your product. Once you register, you are eligible to receive free technical support, as well as updates concerning your ALTEC AIR products.

Register Online at www.AltecAIR.com/registration

Or by Phone 1-800-521-5351 (option 2)

Have the following information available:

Model #: _____ **Serial #:** _____

Company Name: _____ **Location Name:** _____

Shipping Address: _____

City: _____ **State:** _____ **Zip Code:** _____

Contact Name: _____ **Phone #:** () - ext. _____

Email: _____

8. Testing Your Air Dryer

8.1 Safety & Warning Information



WARNING!

Extreme care should be exercised to avoid contact with live electrical circuits. Many procedures performed during installation, testing, and maintenance of this air dryer requires the equipment to be running, creating a situation for potential electrical shock. It is highly recommended that you remove all jewelry before performing any procedures.



CAUTION!

Observe precautions for handling **Electrostatic Sensitive Devices.**

8.2 Testing Consistent Dryer Cycling

Note: For MCA1-4 proceed to the next step, for MDH5-6 skip to step 8.2.4.

8.2.1 MDH 1-4:

Push the tube in and hold the ferrule. While holding the ferrule, pull the tube out. To perform the test properly, disconnect one side at a time.



8.2.2 Place your hand beneath the disconnected tube and feel for air.

- Tower 1 will purge for **60 seconds**
- Tower 2 will purge for **60 seconds**
- Tower 1 will purge for **60 seconds**
- . . . and so on.

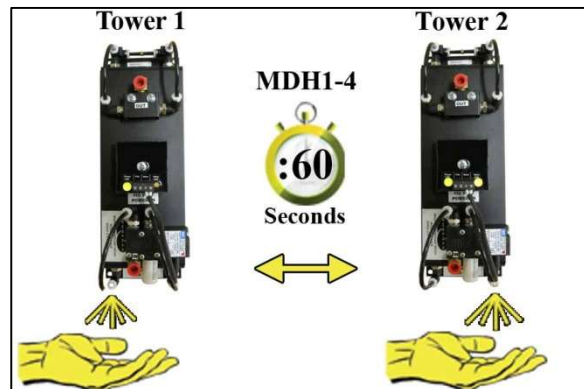

8.2.3 Reinstall tubes after each cycle has been verified.

8.2.4 MDH5-6:

With a small flathead screwdriver, remove the purge mufflers.

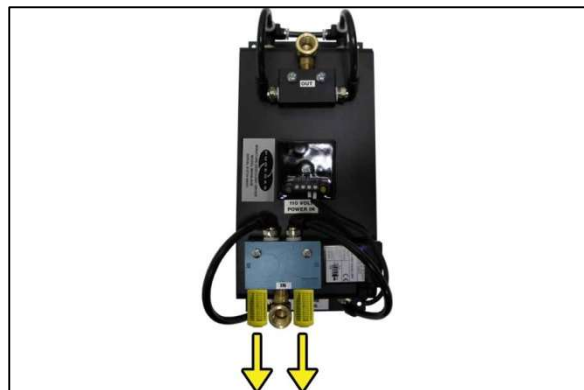

8.2.5 Place your hand beneath the 4 way valve and feel for purging air.

- Tower 1 will purge for **60 seconds**
- Tower 2 will purge for **60 seconds**
- Tower 1 will purge for **60 seconds**
- . . . and so on.

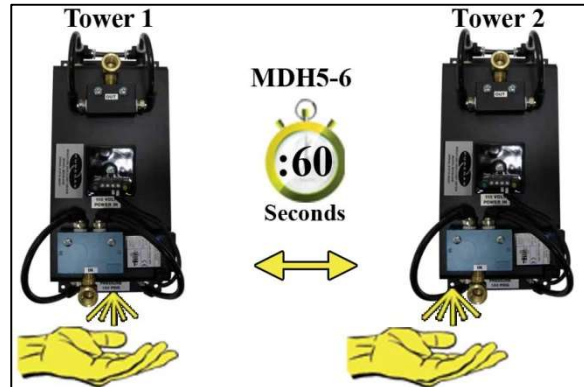

8.2.6 With a small flathead screwdriver, reinstall purge mufflers.

8.3 Measuring Incoming Voltage

8.3.1 Locate the Cycle Timer.

The timer has two (2) sets of terminals (from left-to-right):
The first set will be labeled one of the following:

- **115V** (AC voltage)
- **230V** (AC voltage)
- **12VDC**
- **24VDC**
- **48VDC**

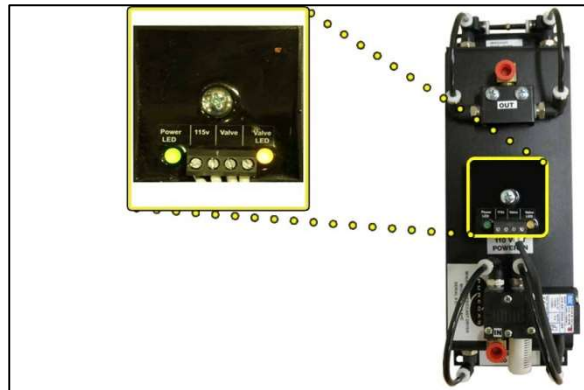

The second set is the 4 Way Valve and is labeled “**Valve**”.

8.3.2 Use a Voltmeter to measure the voltage across the incoming terminals.

The voltage should measure \pm 10%:

- **115 VAC**
- **230 VAC**
- **12 VDC**
- **24 VDC**
- **48 VDC**

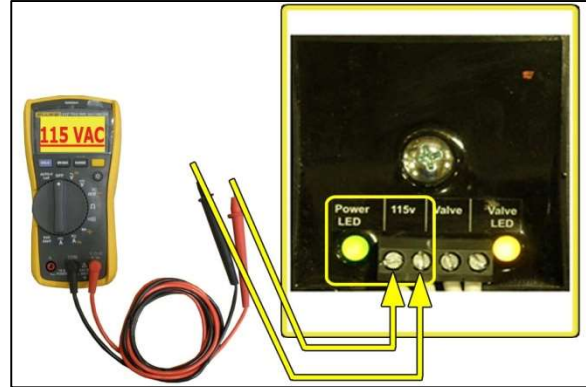

If the incoming voltage measures less than indicated above, it is recommended that steps be taken at your facility to increase the incoming power to the recommended levels.

8.4 Measuring 4 Way Solenoid Voltage

8.4.1 Locate the Cycle Timer.

The timer has two (2) sets of terminals (from left-to-right):

The first set will be labeled one of the following:

- **115V (AC voltage)**
- **230V (AC voltage)**
- **12VDC**
- **24VDC**
- **48 VDC**

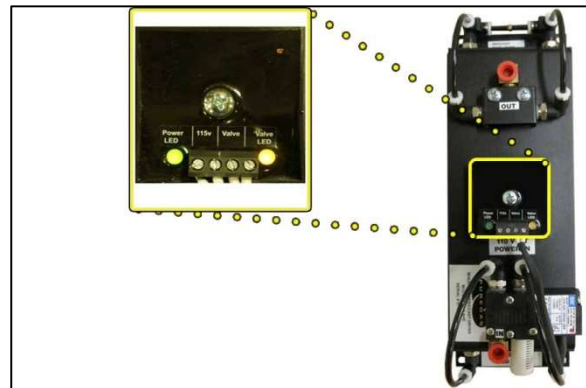

The second set is the 4 Way Valve and is labeled “**Valve**”.

8.4.2 Use a Voltmeter to measure the voltage across the set of “Valve” terminals.

The voltage should measure \pm 10%:

- 115 VAC
- 230 VAC
- 12 VDC
- 24 VDC
- 48 VDC

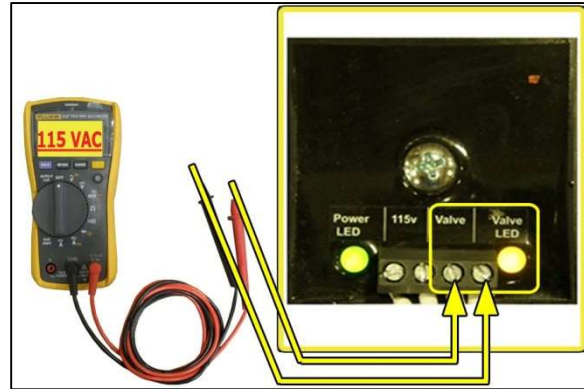

Continue to measure for up to 90 seconds if no voltage is initially measured.

If the voltage does not measure as indicated above replace 4 way solenoid valve. See sections 10.1 for part detail and 10.4 for ordering information.

8.5 Visually Verify Cycle Timer

8.5.1 Locate the Cycle timer.

8.5.2 The timer has two LEDs. Green for incoming power and Amber for the 4 way valve.

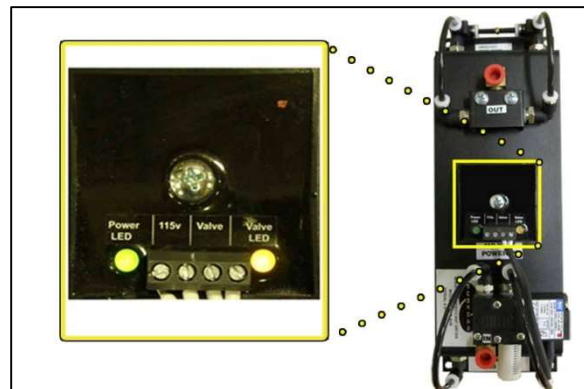

If either light is off see sections 8.3 and 8.4 to verify the cycle timer has correct voltages.

8.6 Test for Purge Muffler Restriction

8.6.1 Using a small flathead screwdriver, remove purge mufflers.

NOTE: The MDH1- 4 will only have one purge muffler.



8.6.2 Verify if the operation of the unit has improved after 4 minutes of cycling.

8.6.2.1 If so, install new purge mufflers using a small flathead screwdriver.

8.6.2.2 If not, re install old purge mufflers using a small flathead screwdriver.

If the Purge Muffler is dirty you should replace it as well. See Section 10.1 for parts and Section 15.2 for ordering.

8.7 Testing Air Fittings & Hoses for Leaks

NOTE: This is a general procedure that can be applied to any fitting or hose that has air pressure in it.

8.7.1 Listen for any 'hissing' sounds which may indicate a fitting or hose air leak.

8.7.2 Use a 1-inch paint brush to dab soapy water on the air fitting or hose connection to be tested.

If air bubbles appear at the connection, this indicates that air is leaking from the connection.



If any leaks are detected, take steps to seal them off (as necessary):

- *Tighten the fitting*
- *Re-connect the hose end*
- *Replace the fitting/hose/component*

9. Maintaining Your Dryer

In order to ensure that your MDH Air Dryer continues to operate efficiently and reliably, ALTEC AIR recommends performing the following maintenance procedures at the specified Six Month intervals.

It is also recommended that you print out the included *Maintenance* log sheet (*section 16*) and record all completed maintenance for historical tracking and reference purposes.

The log sheet includes a Section reference column which indicates the User's Guide section containing the information about the specific procedure. Please refer to these sections for detailed procedural information.

NOTE: When operating at higher ambient temperatures, it is recommended that maintenance be performed more frequently.

9.1 Safety & Warning Information



WARNING!

Extreme care should be exercised to avoid contact with live electrical circuits. Many procedures performed during installation, operation, testing, and maintenance of this air dryer require the equipment to be running, creating a situation for potential electrical shock. It is highly recommended that you remove all jewelry before performing any procedures.



CAUTION!

SHUT DOWN IMMEDIATELY FOR REPAIRS if the air dryer shows any evidence of excessive noise.



CAUTION!
 Observe precautions for handling **Electrostatic Sensitive Devices**.



IMPORTANT!
 After performing any maintenance, always soap test pressure fittings to check for air leaks. Also, check for any loose or disconnected wiring.

9.2 Maintenance Log Sheet

MODEL: _____

LOCATION NAME: _____

SERIAL NUMBER: _____

ADDRESS: _____

DATE INSTALLED: _____

Procedure	Section	Maintenance Interval (Months)				
		6	12	18	24	30
Visually Inspect MDH for Loose Wiring or Hardware	6.5.2	<input type="checkbox"/>	<input type="checkbox"/>	<input type="checkbox"/>	<input type="checkbox"/>	<input type="checkbox"/>
Test Consistent Dryer Cycling	8.2	<input type="checkbox"/>	<input type="checkbox"/>	<input type="checkbox"/>	<input type="checkbox"/>	<input type="checkbox"/>
Measure & Record Incoming Voltage	8.3					
Visually Verify Cycle Timer	8.5	<input type="checkbox"/>	<input type="checkbox"/>	<input type="checkbox"/>	<input type="checkbox"/>	<input type="checkbox"/>
Replace Purge Mufflers	8.6		<input type="checkbox"/>		<input type="checkbox"/>	
Maintenance Performed by:						
Date of Maintenance:						

10. Replacement Parts & Accessories

10.1 Parts

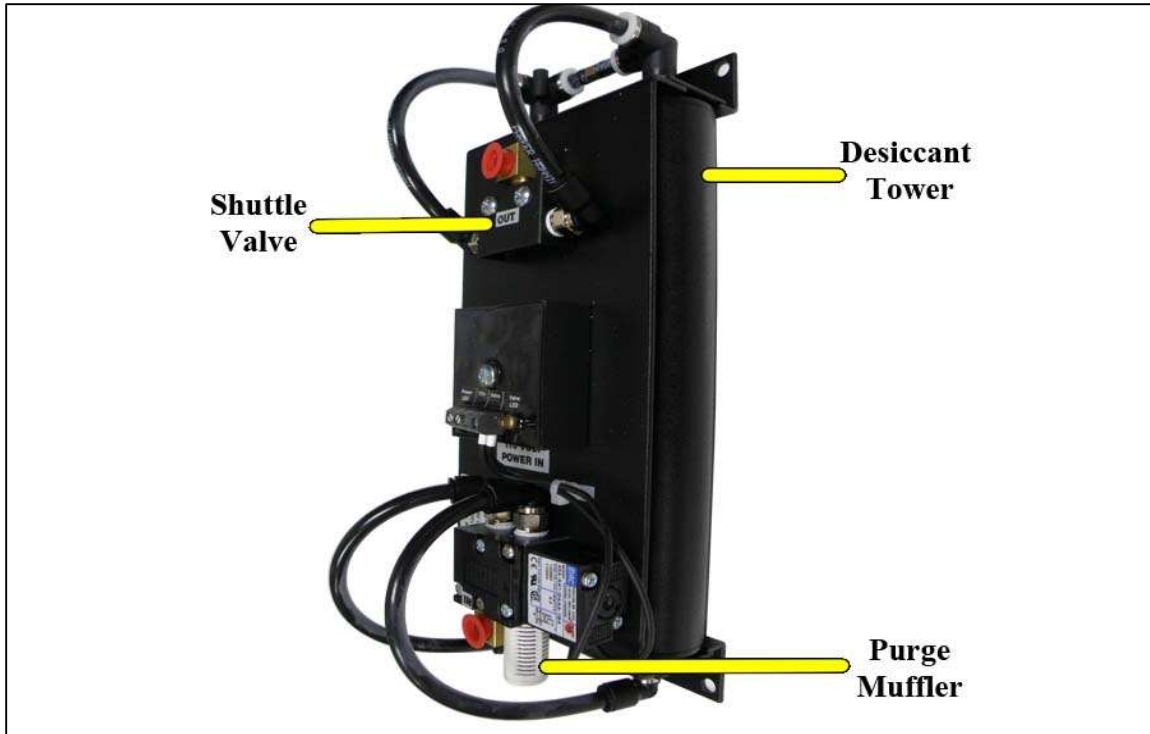

Description	Part Number	Quantity	Recommended Spare
Desiccant Tower			
MDH1	51371		
MDH2	51372		
MDH3	51373	2	
MDH4	51374		
MDH5	51375		
MDH6	51376		
Shuttle Valve			
MCA1-4	61015		✓(1)
MCA5-6	61016	1	
Purge Muffler			
MCA1-4	10040	1	✓
MCA5-6	20504	2	

10.2 Parts Continued

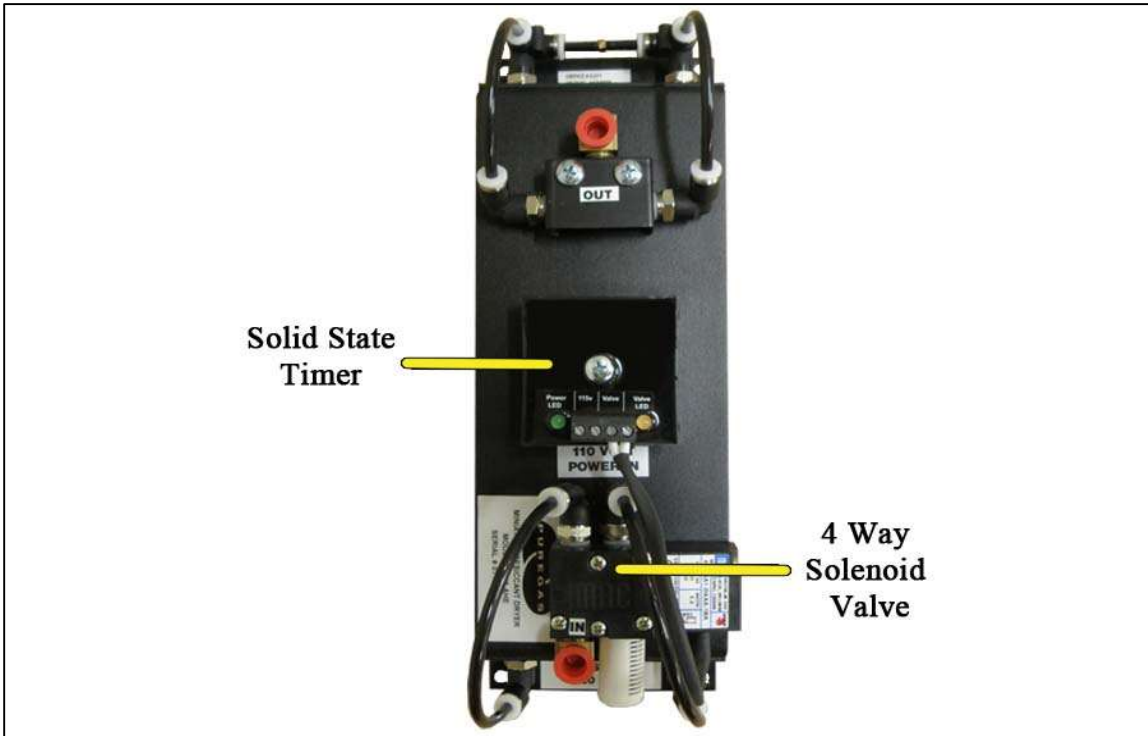

Description	Part Number					Rec'd Spare
	115 VAC	230 VAC	12 VDC	24 VDC	48 VDC	
Solid State Timer	51800	50022	50021	50021	P013155	✓ (1)
4 Way Valve						
MDH1-4	10043	10043-220V	10043-12VDC	10043-24VDC	10043-48VDC	✓ (1)
MDH5-6	51353	51370	P012865	51872	N/A	

10.3 Accessories for Your Air Dryer

	Description	Part Number
	<p>Filter Kit</p> <p>Keeps all impurities from contaminating the desiccant towers. Includes 5 micron pre-filter, 0.01 coalescing pre-filter, and 1.0 micron after-filter.</p>	<p>AD21-MDH14 (MDH1 THRU MDH4)</p> <p>AD21-MDH56 (MDH5 AND MDH6)</p>
	<p>Filter Kit w Regulator</p> <p>Keeps all impurities from contaminating the towers and allows you to regulate your outlet pressure. Includes 5 micron pre-filter, 0.01 coalescing pre-filter, 1.0 micron after-filter, gauge and regulator.</p>	<p>AD21-MDH14-R (MDH1 THRU MDH4)</p> <p>AD21-MDH56-R (MDH5 AND MDH6)</p>
	<p>Replacement Element Kit</p> <p>Includes 5 micron pre-filter, 0.01 coalescing pre-filter, and 1.0 micron after-filter.</p>	<p>ED21-MDH14 (MDH1 THRU MDH4)</p> <p>ED21-MDH56 (MDH5 AND MDH6)</p>
	<p>Moisture Indicator</p> <p>Nickel-plated steel with blue to pink indicator and a brass tee.</p>	<p>Call Factory</p>
	<p>Quiet Box Enclosure</p> <p>A sleek looking box that suppresses sound while protecting your MDH in a NEMA 4 rated bud box.</p>	<p>Call Factory</p>

10.4 Ordering Parts from ALTEC AIR



IMPORTANT!

Instruction for the replacement of individual listed components goes beyond the scope of this User's Guide and will not be covered.

Please refer to the information included with the specific replacement part for this instruction.

Once you have identified your required parts and accessories, contact the ALTEC AIR Inside Sales/Service department to order:

(303) 427-3700 option 2

Fax – (303) 657-2205

sales@AltecAIR.com

11. Service & Repair

11.1 Services Offered at Altec AIR' Facility

- **Complete Dryer Repair**
 - Replace desiccant towers, clean shuttle valve (replace disc if necessary), replace purge mufflers, and verify if both the solid state timer and the 4-way valve are working properly.

11.2 Initiating a Service Transaction

- Contact our Parts & Service Department at **1-800-521-5351 (option 3)** to obtain a Return Authorization (RA) number.
- Carefully package the item(s) to be returned.
- Mark the Return Authorization (RA) number on the outside of the shipping container.
- Include the main address and phone number of the individual to contact for related inquiry and follow-up information.
- Include the purchase order number.

12. Troubleshooting Your Air Dryer

12.1 Before You Call ALTEC AIR

PLEASE READ THIS SECTION FIRST. It is important that you use the following sections in order to diagnose and attempt to fix the problem with your air dryer before placing a call to ALTEC AIR Technical Support.

This troubleshooting guide is intended to simplify the isolation of problems, present possible causes, provide test procedures for verification, and suggest corrective actions to restore the air dryer back to normal operation. Each section begins with the most likely cause(s) of the issue. Otherwise, they start from the simplest possibilities and progress to more complicated ones.

This troubleshooting guide is designed to be easy to follow and very effective when used properly. It is suggested to always start at the beginning of the specific problem section and continue in sequence, following the procedures indicated.

12.2 Safety & Warning Information



WARNING!

For your safety, all the information in this User's Guide must be followed to minimize the risk of electrical shock, and prevent property damage or personal injury.



WARNING!

Extreme care should be exercised to avoid contact with live electrical circuits. Many procedures performed during installation and testing of this air dryer require the equipment to be running, creating a situation for potential electrical shock. It is highly recommended that you remove all jewelry before performing any procedures.



IMPORTANT!

Performing procedures not described in this User's Guide or installing components not supplied by ALTEC AIR is NOT RECOMMENDED AND MAY VOID THE WARRANTY.

12.3 Low Pressure or Flow

Possible Cause	Check	Corrective Action
No power to unit	Verify power is supplied to the unit (section 8.4)	Troubleshoot facility power supply to air dryer
Dirty or obstructed inlet filter	Verify inlet air filter elements are clean	Replace filter elements (section 10.3)
Inlet and outlet ports reversed	Verify ports for proper orientation (section 6.5.4)	Reconnect properly
Excessive purge		Test for Excessive Purge (section 12.4)

12.4 Excessive Purge

Possible Cause	Check	Corrective Action
Defective timer	Verify timing cycle (section 8.5)	Replace timer (section 10.2)
Defective 4 way solenoid valve	Test for consistent dryer cycle, and verify voltage (section 8.2 and 8.4)	Replace 4 way solenoid valve (section 10.2)

12.5 Delivers Wet Air

Possible Cause	Check	Corrective Action
High inlet temperature	Verify inlet temperature is below 100°F.	Reduce inlet air temperature.
Air flow in excess of rated capacity	Verify outlet flow does not exceed air dryer's rated flow	Reduce air usage downstream.
Low inlet pressure		Test for low pressure (section 12.3)
Defective timer	Verify timing cycle (section 8.5)	Replace timer (section 10.2)
Defective 4 way solenoid valve	Test for consistent purge cycle, and verify voltage (section 8.2 and 8.4)	Replace solenoid valve (section 10.2)
Restricted Purge	Test for purge muffler restriction (section 8.6)	Replace mufflers (section 10.1)

12.6 Contacting ALTEC AIR Technical Support

Please read the *Before You Call ALTEC AIR* section (12.1)

Once you have exhausted all of the potential problems and solutions covered in the *Troubleshooting Your Dryer* section, and you still require further assistance to correct a problem, contact ALTEC AIR Technical Support:

(800) 521-5351 (option 1)

Have the following information available:

Trouble Ticket # (if following-up on a previous call): _____
Technician Name: _____ **Phone #:** _____
Model #: _____ **Serial #:** _____
Company Name: _____ **Location Name:** _____
City: _____ **State:** _____

13. Appendix

13.1 Model Number Coding

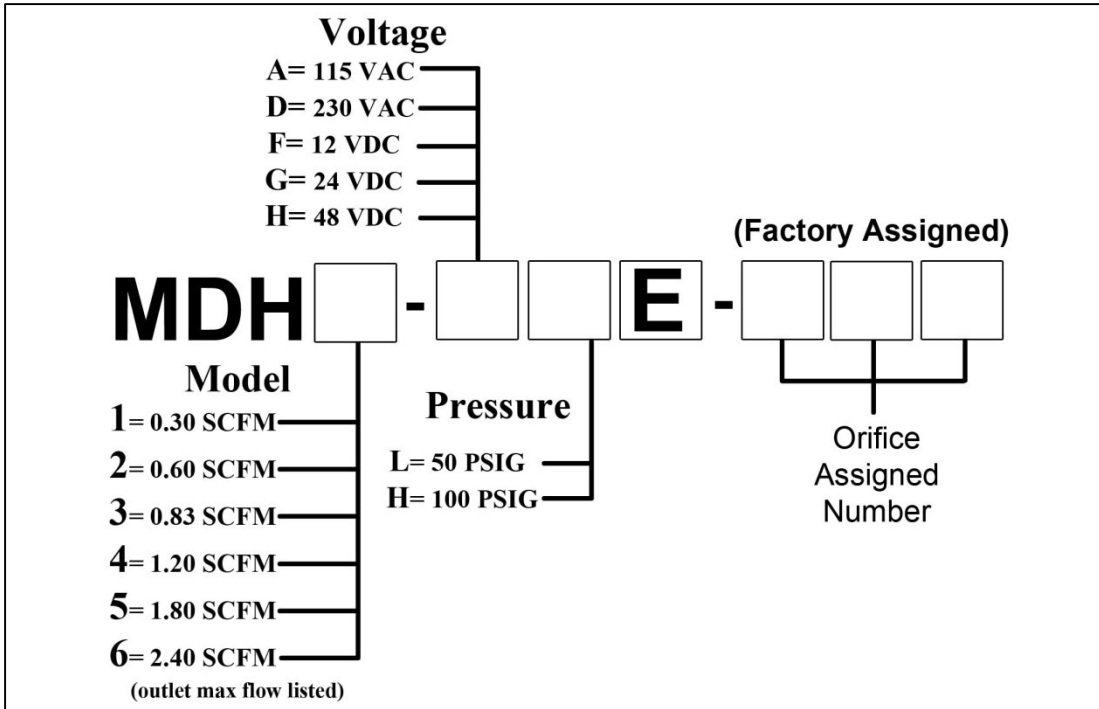

13.2 Wiring Diagram

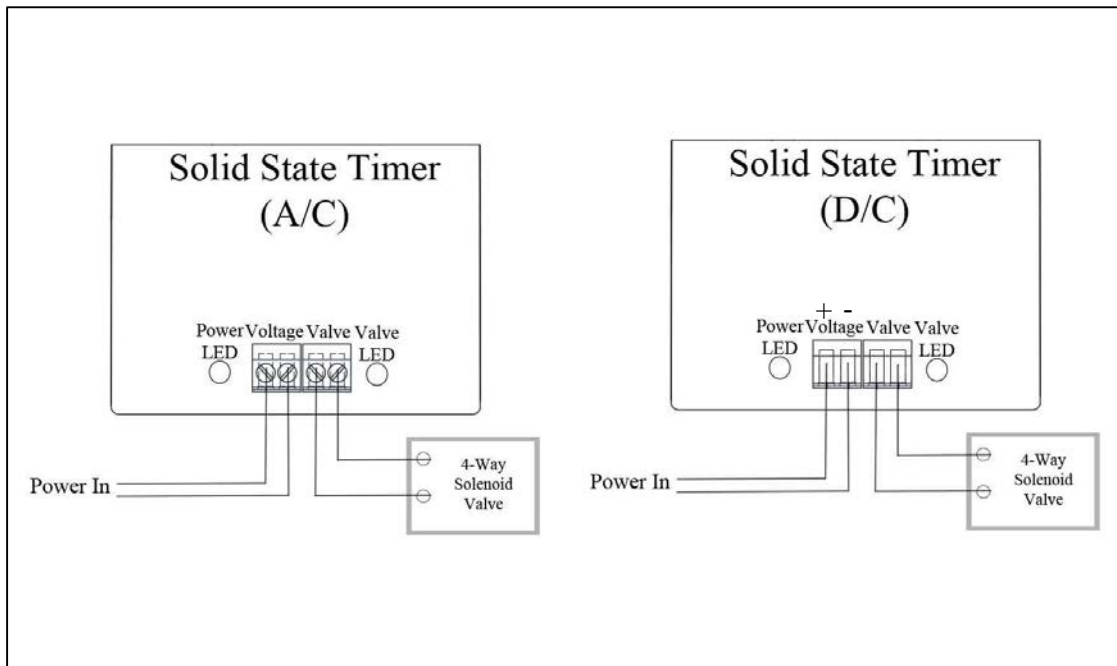

14. Limited Warranty Agreement

ALTEC AIR products carry a one (1) year warranty against defective workmanship and material. This period starts at date of shipment. Not included are the components subject to normal replacement during a year's operating time.

No claims for labor in replacing defective parts or for consequential damages will be allowed. Replacement parts will be invoiced in the regular way, with invoices subject to adjustment after the parts claimed defective are examined at our factory. In addition, no material or parts will be accepted at our factory for in-warranty repairs or credit without previous authorization from ALTEC AIR.

Responsibility for damages incurred in transit will be borne by the user and the user in turn should file any damage claim against the carrier. All warranty items are F.O.B. Broomfield, Colorado. Freight charges are the responsibility of the user.

This warranty shall not apply to any ALTEC AIR product which shall have been repaired or altered in any way by anyone other than ALTEC AIR or authorized personnel so as to affect, in our judgment, its proper functioning or reliability, neither will it apply to any product which has been subject to misuse, negligence, or accident. The installation of unauthorized non ALTEC AIR parts will void the warranty on those ALTEC AIR products.

Registration Reminder

If you haven't already done so, please take a moment to register your ALTEC AIR MDH SERIES AIR DRYER. **Registering is necessary to activate this Limited Warranty on your product.** Once you register, you are eligible to receive free technical support, as well as updates concerning your ALTEC AIR products.

See Section 7. for details on Registering Your Air Dryer.

15. Contacting ALTEC AIR

15.1 General

ALTEC AIR, LLC
226A Commerce Street
Broomfield, Colorado 80020

(800) 521-5351

(303) 427-3700

Fax – (303) 657-2205

sales@AltecAIR.com

www.airdryers.com

15.2 Sales

(800) 521-5351

Fax – (303) 657-2205

sales@AltecAIR.com

15.3 Service

(800) 521-5351 **(option 3)**

Fax – (303) 657-2205

15.4 Technical Support

(800) 521-5351 **(option 1)**

DON'T FORGET TO REGISTER YOUR MDH AIR DRYER!

See Section 7. for details on Registering Your Air Dryer.

