

HR Series Air Dryer



User's Guide

Models covered:

HR1 HR2 HR3 HR4 HR5 HR6 HR6.5 HR7
HR5-V1 HR6-V1 HR6.5-V1 HR7-V1





WARNING:

This product can expose you to chemicals including Lead, which is known to the State of California to cause cancer/birth defects or other reproductive harm. For more information go to www.P65Warnings.ca.gov

1. Welcome & Congratulations

Congratulations on your purchase of a new HR SERIES AIR DRYER! We here at Altec AIR are very proud of our products. We are committed to providing you with the best value and service possible.

We are sure that you will be satisfied with your new unit and would like to thank you for choosing Altec AIR for your air dryer requirements. We also hope that you will continue to choose us for your future Compressed Air Treatment and related products purchases.

For information about this and other Altec AIR products, please visit us on the web at

www.AltecAIR.com

2. Introduction

PLEASE READ THIS USER'S GUIDE THOROUGHLY AND SAVE FOR FUTURE REFERENCE.

This User's Guide is provided for the benefit of our customers and contains information and direction specific to the Altec AIR HR SERIES AIR DRYER. It will cover topics including safety, specifications, installation, testing, maintenance, and troubleshooting issues. Observation and compliance with this User's Guide will ensure the maximum life and efficiency of your air dryer.

This User's Guide should be read thoroughly prior to installing, operating, or servicing the air dryer in order to become familiar with the recommended procedures. This will minimize the possibility of personal injury or damage to the dryer due to improper operation or handling.

3. Table of Contents

1. Welcome & Congratulations	3	10.1 Parts	22
2. Introduction	3	10.2 Parts Continued.....	23
3. Table of Contents.....	4	10.3 Accessories for your Air Dryer.....	24
4. Safety & Warning Information	5	10.4 Accessories for Your Air Dryer Continued.....	25
5. Overview & Specifications.....	6	10.5 Tower Reassembly (See section 10.1 diagram).....	25
5.1 Product Description	6	10.6 Ordering Parts from Altec AIR.....	26
5.2 Key Features	6	11. Service & Repair.....	27
5.3 HR Series Air Dryer Models	6	11.1 Services Offered by the Altec AIR's Facility	27
5.4 Technical Specifications.....	7	11.2 Initiating a Service Transaction	27
6. Installing Your Air Dryer	8	12. Troubleshooting Your Air Dryer	27
6.1 Safety & Warning Information	8	12.1 Before You Call Altec AIR.....	27
6.2 Before You Begin.....	9	12.2 Safety & Warning Information	28
6.3 Included Contents	9	12.3 Low Pressure	29
6.4 Required Tools and Materials.....	9	12.4 Excessive Purge	29
6.5 Recommended Dryer Installation	10	12.5 Delivers Wet Air.....	29
6.6 Installation Steps.....	10	12.6 Contacting Altec AIR Technical Support	30
6.7 Installation Checklist	15	13. Appendix	31
7. Registering Your HR Series Air Dryer.....	15	13.1 Model Number Coding	31
8. Testing Your Air Dryer.....	16	13.2 Wiring Diagram	32
8.1 Safety & Warning Information	16	14. Limited Warranty Agreement.....	33
8.2 Testing Consistent Dryer Cycling.....	17	Registration Reminder	33
8.3 Visually Verifying Incoming Voltage ...	18	15. Contacting Altec AIR	34
8.4 Measuring Solenoid Voltage	18	15.1 General.....	34
8.5 Testing Air Fittings & Hoses for Leaks	191	15.2 Sales.....	34
9. Maintaining Your Dryer	202	15.3 Service	34
9.1 Safety & Warning Information	21	15.4 Technical Support.....	34
9.2 Maintenance Log Sheet	22	16. Maintenance Log Sheet	35
10. Replacement Parts & Accessories	22		

4. Safety & Warning Information

This section contains general information about safety and warning points to consider and adhere to during installation and maintenance of your air dryer. PLEASE READ THIS SECTION BEFORE PERFORMING ANY OPERATION OR PROCEDURE ON YOUR AIR DRYER.

Additional warnings specific to an operation or procedure will also be presented throughout the following sections. These will include the  symbol as well as a label of “**WARNING!**”, “**CAUTION!**”, or “**IMPORTANT!**” Please be sure to pay close attention for these warnings and read them as you encounter them.



IMPORTANT!

Performing procedures not described in this User's Guide MAY VOID THE WARRANTY.



IMPORTANT!

Appropriate inlet filtration is **MANDATORY** and outlet filtration is recommended for all applications.



IMPORTANT!

Each air dryer is sized for specific operating conditions. For **OPTIMUM** performance, the maximum available operating pressure should be maintained across the unit. Any pressure reduction or flow control should be done downstream of the unit. Depending on the magnitude of the change, the size of the desiccant chambers or orifice may need to be changed.

5. Overview & Specifications

5.1 Product Description

The HR SERIES AIR DRYER from Altec AIR is a compact, regenerative desiccant air dryer designed to dry compressed air to a standard pressure dew point (PDP) of -40°F. Optional performance of -100°F atmospheric dew point (ADP) or -100°F pressure dew point (PDP) can be achieved. The pressure-swing adsorption (PSA) process used is fully automatic and will remain consistent with minimal required periodic maintenance.

5.2 Key Features

- Ultra-dry air to better than -100°F dew point
- Fully re-pressurizing design for steady outlet pressure
- Inlet flow capacities of 3 to 50 SCFM at 100 PSIG
- Compact, lightweight design requires minimal space
- Ideal for OEM and point-of-use applications

5.3 HR Series Air Dryer Models

Model	Inlet Flow	Purge Flow	Outlet Flow
HR1	3.0	0.8	2.2
HR2	6.0	1.6	4.4
HR3	9.0	2.4	6.6
HR4	12.0	3.2	8.8
HR5	16.0	3.4	12.6
HR6	25.0	5.4	19.6
HR6.5	35.0	7.8	27.2
HR7	50.0	10.8	39.2

Notes:

1. Flow capacities in SCFM shown are for standard units operated at 100 PSIG and outlet dew point of -40°F PDP.
2. Inlet and outlet flow capacities will be greater at higher pressures and lower at lower pressures. Consult factory for other conditions.
3. Standard compressed air inlet conditions are 100°F saturated.

Operating Pressure Ranges

- All 115/230VAC and 24VDC standard models 30-150 PSIG
- All 12VDC models without "-V1" option: 30-125 PSIG
- All models and all voltages with "-V1" option: 30-175 PSIG

5.4 Technical Specifications

Dimensions	HR1 13.6" H x 7.4" W x 5.2" D; 8-lbs (3.6kg) HR2 18.2" H x 7.4" W x 5.2" D; 9-lbs (4.1kg) HR3 17.3" H x 7.4" W x 5.2" D; 10-lbs (4.5kg) HR4 21.1" H x 7.4" W x 5.2" D; 11-lbs (5.0kg) HR5 33.0" H x 9.5" W x 6.5" D; 29-lbs (13kg) HR6 41.9" H x 9.5" W x 6.5" D; 34-lbs (15kg) HR6.5 39.3" H x 10.0" W x 7.0" D; 59-lbs (27kg) HR7 46.3" H x 10.0" W x 7.0" D; 65-lbs (30kg)
Voltage Requirements	115 VAC 50/60 Hz 1Ph 230 VAC 50/60 Hz 1Ph 12 VDC 24 VDC Allowable supply voltage fluctuation +/- 10%
Power	34W Max
Environmental Ratings	U.S.: NEMA 4 Outside U.S.: Indoor Use Only Altitude: Up to 3000 meters (9842 ft) Relative Humidity: Up to 90% non-condensing Pollution Degree 3
Operating Ambient Temperature Range	33° to 125° F (0.5° to 52° C)
Inlet Temperature	≤ 100°F Recommended 125°F Maximum
Maximum Inlet Pressure	Standard "-1/-2" (115/230 VAC) models: 150 PSIG High Pressure "-V1" models: 175 PSIG * HR5/6/6.5/7-3 (12 VDC) units: 125 PSIG Refer to product data label for other model variant ratings
Cycle Timer	Solid State with Memory
Purge Cycle	HR1-HR4 33 seconds purge 12 seconds re-pressurizing 45 seconds per side continuous HR5-HR7 66 seconds purge 24 seconds re-pressurizing 90 seconds per side continuous
Separation Media	4A Molecular Sieve
Noise Level	<90 dBA
Inlet / Outlet Connections	HR1-HR4 3/8" NPT Female HR5-HR7 1/2" NPT Female

6. Installing Your Air Dryer

6.1 Safety & Warning Information



WARNING!

Extreme care should be exercised to avoid contact with live electrical circuits. Many procedures performed during installation and testing of this air dryer require the equipment to be running, creating a situation for potential electrical shock. It is highly recommended that you remove all jewelry before performing any procedures.



CAUTION!

Proper Installation & Maintenance as outlined in this User's Guide is extremely important to ensure the reliability and longevity of the equipment as well as prevent damage or personal injury. If the product is installed or used in a manner not specified by the manufacturer, the protection provided by the equipment may be impaired.



CAUTION!

Supplied voltage and power to dryer must meet the requirements of Table 5.4.



CAUTION!

Do **NOT** exceed the SCFM outlet flow capacity of the dryer. Be aware of what your dryer is rated for before you install your HR Series Air Dryer.

6.2 Before You Begin

6.2.1 Carefully inspect the entire unit including the shipping box for **ANY DAMAGE CAUSED BY SHIPPING**. If any shipping damage is detected, it is important to file a claim with the shipping company prior to continuing the installation procedures.

6.2.2 Read the entire *Installing Your Air Dryer* section to familiarize yourself with the components and procedures before performing the installation.

6.2.3 Verify the installation location of the air dryer:

6.2.3.1 Ambient temperature is between 33° and 125°F

NOTE: Higher temperatures will decrease component lifespan.

6.2.3.2 Supplied power meets the voltage and power requirements of Table 5.4.

6.3 Included Contents

- (1) HR Series Air Dryer
- (1) User's Guide (not shown)
- (2) Purge Mufflers

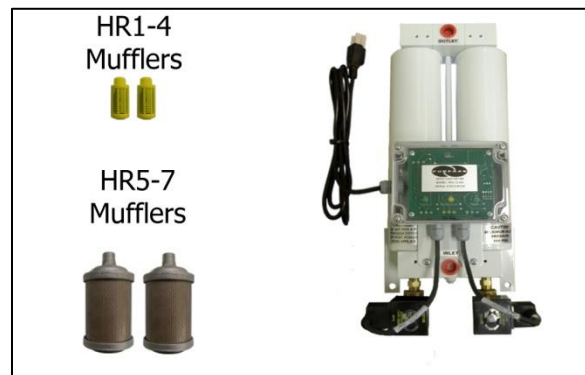

6.4 Required Tools and Materials

- Needle nose pliers
- Mounting hardware
- Drill
- Drill bit (varies on mounting hardware)

- Small adjustable wrench
- Medium adjustable wrench (used only when installing a Complete System)
- Flathead screwdriver
- Cup of soapy water
- 1-inch paint brush (recommended)

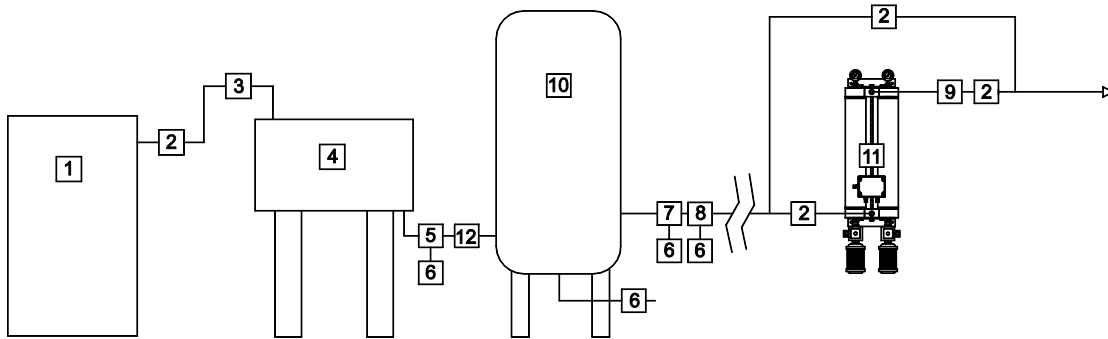

6.5 Recommended Dryer Installation

Ref.#	Description	Ref.#	Description
1	Compressor	7	Pre-Filter, 5.0 Micron Coalescing
2	Shut-off Valve	8	Pre-Filter, 0.01 Micron Coalescing
3	Flex Connector	9	Post-Filter Regulator Assembly
4	Aftercooler	10	Storage Tank
5	Liquid Separator	11	HR Series Air Dryer
6	Drain Valve	12	Check Valve

6.6 Installation Steps



IMPORTANT!

To properly operate the Air Dryer, Altec AIR recommends that all essential elements, air filtration and certain options be installed. **SEE SECTION 10.3**

6.6.1 Remove the HR Series Air Dryer from packaging. For removal from the box and transporting to the installation location, grasp the product by the cylindrical desiccant towers or the mounting brackets. **DO NOT** use mufflers, valves, gauges, electrical enclosure, or other components as carry handles. For dryers HR6 and larger, a 2-person lift is recommended whereby the product is carried by one person on each end using the mounting brackets or desiccant towers as grab handles.

6.6.2 Check for loose parts or wiring.

NOTE: If ANY SHIPPING DAMAGE is detected, file a claim with the shipping company prior to continuing the installation procedures.



6.6.3 Place the HR Series Air Dryer at the operating location.

6.6.4 With needle nose pliers remove and discard plugs.

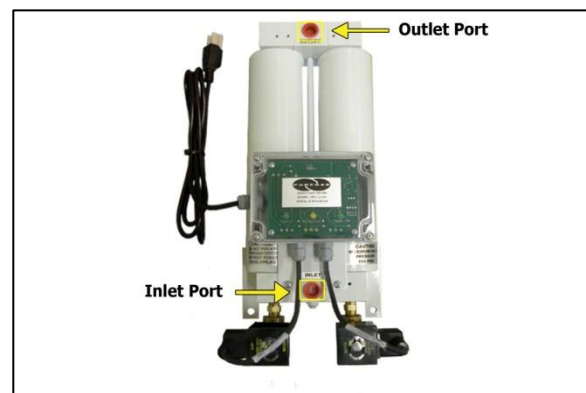

6.6.5 Install purge mufflers.

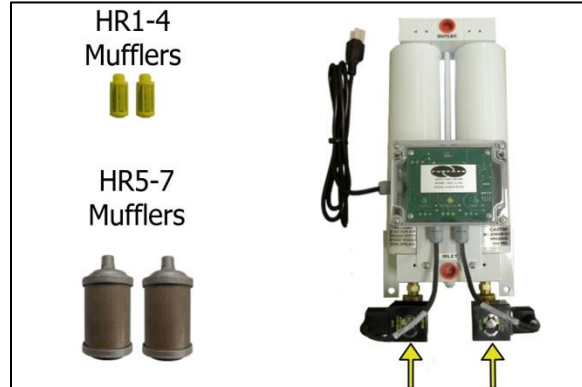

6.6.6 Install inlet and outlet filters, fittings, or assemblies to the air dryer. Installation of interconnected accessories which are not manufactured by Altec AIR shall be assembled and installed per the manufacturer instructions included with the accessories.



⚠ CAUTION: When installing a typical Complete Air Dryer, or Point-of-Use System, Altec AIR recommends assembling ALL components before mounting the HR Series Air Dryer.

6.6.7 Pre-drill holes in wall, referring to chart below for dimensions, and install wall mount hardware. (See chart below)

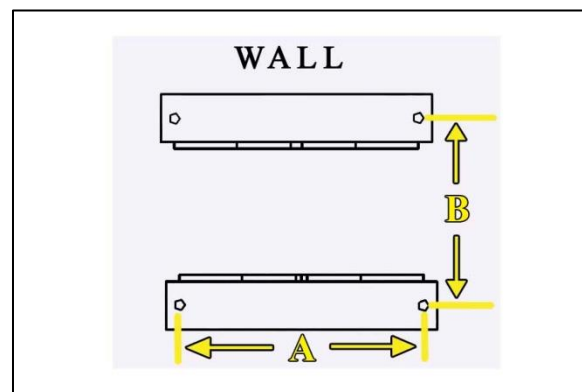

⚠ IMPORTANT: Product may be mounted to drywall, studs, concrete, block, or other surfaces and materials. Hardware such as anchors, screws, or bolts shall be appropriately rated for the weight of the product (refer to Table 5.4 Dimensions for product weights).

⚠ IMPORTANT: When mounting, allow 2-1/2" above unit for tower removal and replacement.

Model	Width (A) x Height (B)
HR1 - HR4	5-3/4" x 2-3/4"
HR5	7" x 23-5/8"
HR6	7" x 32-1/2"
HR6.5	9" x 30-1/8"
HR7	9" x 37-1/8"

6.6.8 Mount unit to wall using secure wall mounting hardware.

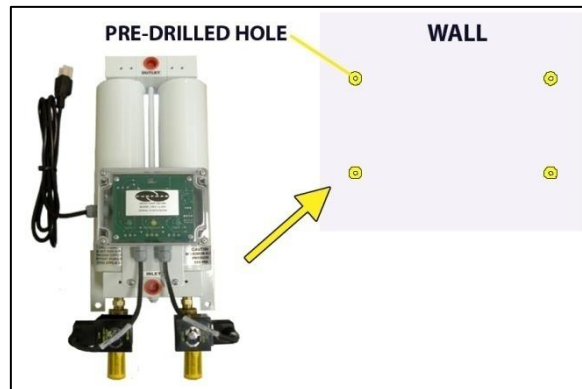

6.6.9 Connect the air supply line to the inlet and outlet port.

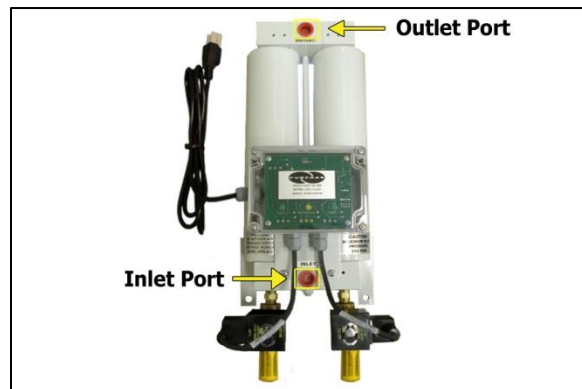

6.6.10 Pressurize the HR dryer to line pressure for at least 30 seconds prior to powering up the unit.

⚠ CAUTION: Do not exceed SCFM outlet flow capacity of the dryer.

6.6.11 Plug in the Power Cord to an outlet:

- 115 VAC power outlet, 1 Ph.
- 230 VAC power outlet, 1 Ph.
- 12 VDC
- 24 VDC

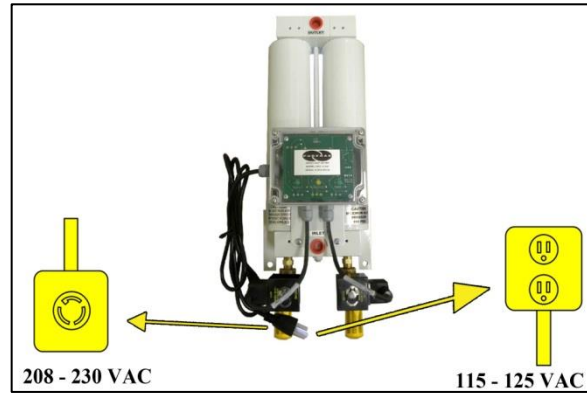

NOTE: Customer must supply a 230 VAC plug to match their receptacle. For DC units, connect to correct voltage and polarity.

6.6.12 Check for air leaks:

NOTE: This is a general procedure that can be applied to any fitting or hose that has air pressure in it.

6.6.12.1 Listen for any 'hissing' sounds which may indicate a fitting or hose air leak.

6.6.12.2 Use a 1-inch paint brush to dab soapy water on the air fitting or hose connection to be tested.

If air bubbles appear at the connection, this indicates that air is leaking from the connection.

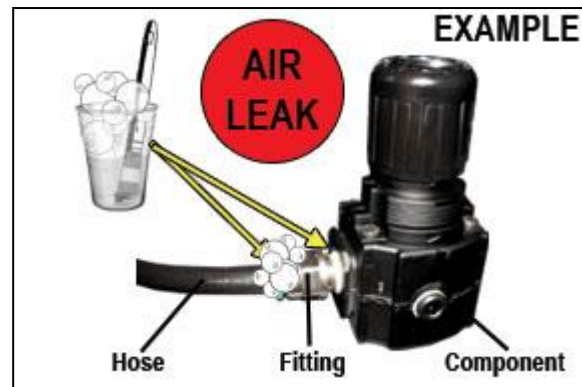

If any leaks are detected, take steps to seal them off (as necessary):

- *Tighten the fitting*
- *Re-connect the hose end*
- *Replace the fitting / hose / component*

6.6.13 REGISTER YOUR AIR DRYER. *See section 7. for details.***6.7 Installation Checklist**

- No shipping damage was detected.
- Wall mounted properly.
- No air leaks are present.

7. Registering Your HR Series Air Dryer

Please take a moment to register your Altec AIR HR SERIES AIR DRYER. Registering is necessary to activate the Limited Warranty on your product. Once you register, you are eligible to receive free technical support, as well as updates concerning your Altec AIR products.

Register Online at <http://www.AltecAIR.com/registration.html>

Or by Phone 1-800-521-5351 (option 2)

Have the following information available:

Model #: _____ **Serial #:** _____

Company Name: _____ **Location Name:** _____

Shipping Address: _____

City: _____ **State:** _____ **Zip Code:** _____

Contact Name: _____ **Phone #:** () - ext. _____

Email: _____

8. Testing Your Air Dryer

8.1 Safety & Warning Information



WARNING!

Extreme care should be exercised to avoid contact with live electrical circuits. Many procedures performed during installation, testing, and maintenance of this air dryer requires the equipment to be running, creating a situation for potential electrical shock. It is highly recommended that you remove all jewelry before performing any procedures.



CAUTION!

Observe precautions for handling **Electrostatic Sensitive Devices.**

8.2 Testing Consistent Dryer Cycling

8.2.1 Place your hand beneath the purge mufflers to feel for purging air.

Air should:

For HR1-HR4:

- Tower 1 will purge for **33 Seconds**, and re-pressurize for 12 seconds
- Tower 2 will purge for **33 Seconds**, and re-pressurize for 12 seconds
- Tower 1 will purge for **33 Seconds**, and re-pressurize for 12 seconds
- ...and so on.



For HR5-HR7:

- Tower 1 will purge for **66 Seconds**, and re-pressurize for 24 seconds
- Tower 2 will purge for **66 Seconds**, and re-pressurize for 24 seconds
- Tower 1 will purge for **66 Seconds**, and re-pressurize for 24 seconds
- ...and so on.

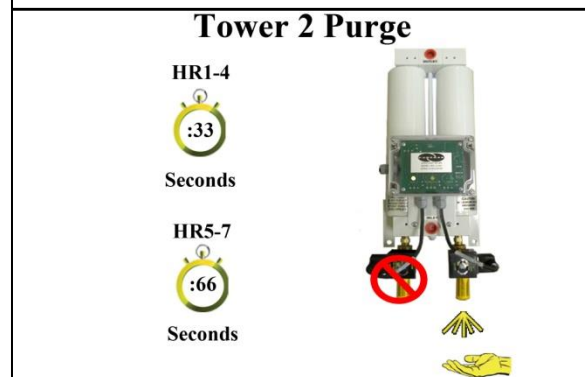
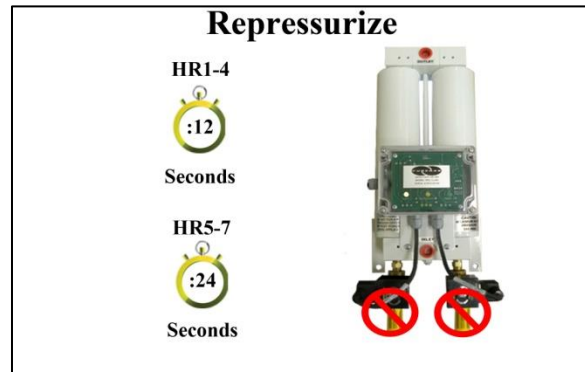

8.3 Visually Verifying Incoming Voltage

- 8.3.1** LEDs will illuminate to indicate what the current cycle status is. Tower 1, Repressurize or Tower 2.



8.4 Measuring Solenoid Voltage

- 8.4.1** Unplug the HR from the power source.

- 8.4.2** Locate the Purge Solenoids screws.



- 8.4.3** Use a flathead screwdriver, loosen screw, and pull back solenoid valve cover.

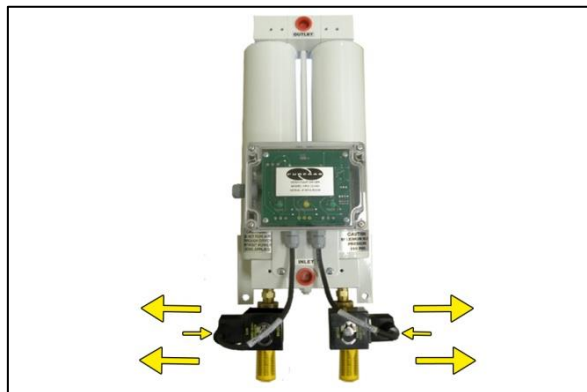

8.4.4 Plug the HR back into the power source. While the unit is running, use a Voltmeter to measure the voltage across two terminals.



8.4.5 Continue to measure for up to 90 seconds if no voltage is initially measured.

The voltage should conform with the Voltage Requirements of Table 5.4

If the voltage does not measure as indicated above, visually verify incoming voltage (section 8.3). If voltage to the solenoid is incorrect then replace the cycle timer. If voltage to the solenoid is correct and the solenoid is not purging properly, then replace the solenoid. See sections 10.1 for part detail and 10.6 for ordering information.

8.5 Testing Air Fittings & Hoses for Leaks

NOTE: This is a general procedure that can be applied to any fitting or hose that has air pressure in it.

8.5.1 Listen for any 'hissing' sounds which may indicate a fitting or hose air leak.

8.5.2 Use a 1-inch paint brush to dab soapy water on the air fitting or hose connection to be tested.

If air bubbles appear at the connection, this indicates that air is leaking from the connection.



If any leaks are detected, take steps to seal them off (as necessary):

- *Tighten the fitting*
- *Re-connect the hose end*
- *Replace the fitting / hose / component*

9. Maintaining Your Dryer

In order to ensure that your HR Series Air Dryer continues to operate efficiently and reliably, Altec AIR recommends performing the following maintenance procedures at the specified Six-Month intervals.

It is also recommended that you print out the included *Maintenance* log sheet (*section 16*) and record all completed maintenance for historical tracking and reference purposes.

The log sheet includes a Section reference column which indicates the User's Guide section containing the information about the specific procedure. Please refer to these sections for detailed procedural information.

NOTE: When operating at higher ambient temperatures, it is recommended that maintenance be performed more frequently.

9.1 Safety & Warning Information



WARNING!

Extreme care should be exercised to avoid contact with live electrical circuits. Many procedures performed during installation, operation, testing, and maintenance of this air dryer require the equipment to be running, creating a situation for potential electrical shock. It is highly recommended that you remove all jewelry before performing any procedures.



CAUTION!

SHUT DOWN IMMEDIATELY FOR REPAIRS if the air dryer shows any evidence of excessive noise.



CAUTION!

Observe precautions for handling **Electrostatic Sensitive Devices**.



IMPORTANT!

After performing any maintenance, always soap test pressure fittings to check for air leaks. Also, check for any loose or disconnected wiring.

9.2 Maintenance Log Sheet

MODEL: _____ LOCATION NAME: _____

SERIAL NUMBER: _____ ADDRESS: _____

DATE INSTALLED: _____

Procedure	Section	Maintenance Interval (Months)				
		6	12	18	24	30
Visually Inspect HR for Loose Wiring or Hardware	6.6.2	<input type="checkbox"/>	<input type="checkbox"/>	<input type="checkbox"/>	<input type="checkbox"/>	<input type="checkbox"/>
Test Consistent Dryer Cycling	8.2	<input type="checkbox"/>	<input type="checkbox"/>	<input type="checkbox"/>	<input type="checkbox"/>	<input type="checkbox"/>
Visually Verify Cycle Timer has Voltage	8.3	<input type="checkbox"/>	<input type="checkbox"/>	<input type="checkbox"/>	<input type="checkbox"/>	<input type="checkbox"/>
Replace Purge Mufflers	10.2		<input type="checkbox"/>		<input type="checkbox"/>	
Replace Filter Elements (If installed)	10.3		<input type="checkbox"/>		<input type="checkbox"/>	
Maintenance Performed by:						
Date of Maintenance:						

10. Replacement Parts & Accessories

10.1 Parts

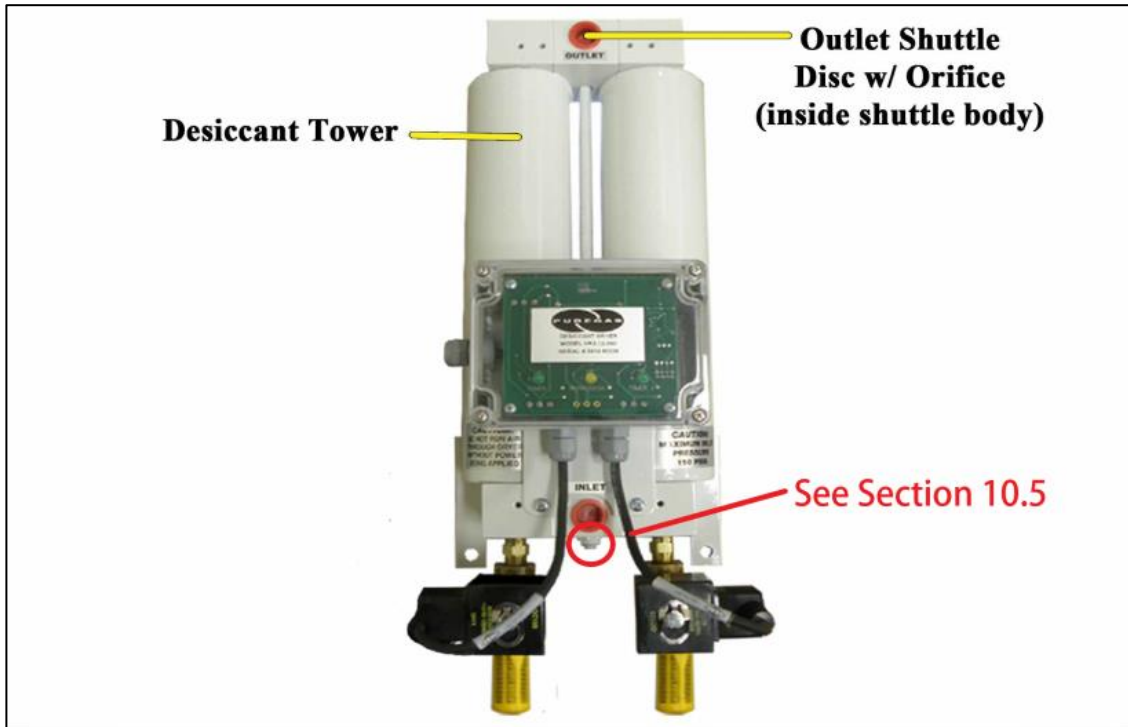

Description	Part Number	Quantity	Recommended Spare
Desiccant Tower	HR1 HR2 HR3 HR4 HR5 HR6 HR6.5 HR7	20100 20200 20300 20400 30500 30600 30650 30700	2
Outlet Shuttle Disc w/ Orifice*	HR1-4 HR5-7 HRV1	50085-## 3### 51826-###	1

* Consult factory for special orifice sizing.



Represents the orifice size number, please refer to your dryer identification label for reference

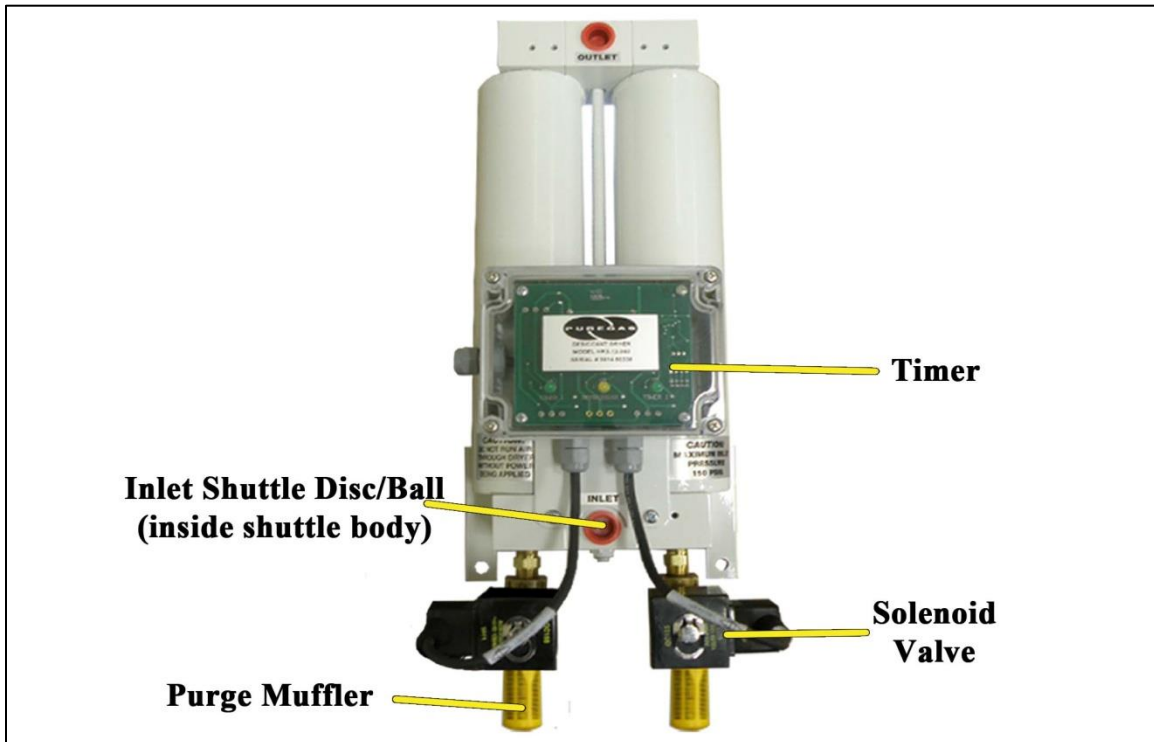

10.2 Parts Continued



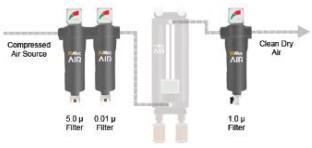

Description	Part Number		Quantity	Recommended Spare
	HR1-4	HR5-7		
Inlet Shuttle Disc	50080		1	
Inlet Shuttle Ball		51518	1	
Purge Muffler	20502	30802	2	✓ (2)
Timer 115 VAC 230 VAC 24 VDC 12 VDC	20507-115V 20507-230V 52131 52131	50090-115V 50090-230V 52135 52135	1	✓ (1)
Solenoid Valve 115 VAC 230 VAC 24 VDC 12 VDC	20009 20010 51986 P013147	30009 30010 51462 P017727	2	✓ (2)

10.3 Accessories for your Air Dryer

	Description	Model Number	Part Number
	Tower Gauge Kit Two 0-160 PSI gauges, which show the pressures the towers are operating at.	HR1-4 HR5-7	20500 30800
	Bypass Valve Kit Three ball valves, brass fittings and 6' of tubing, that allows the dryer and filters to be taken off-line for maintenance without interrupting compressed air flow.	HR1-4 HR5-7	20511 30811
	Filter Kit Includes 5.0 micron coalescing pre-filter, 0.01 micron coalescing pre-filter, and 1.0-micron particulate post-filter. Keeps all impurities from contaminating the desiccant towers.	HR1-4 HR5-7	AD21-HR14 AD21-HR57

	<p>Filter Kit w Regulator Includes 5.0 micron coalescing pre-filter, 0.01 micron coalescing pre-filter, and 1.0-micron particulate post-filter, gauge, and regulator. Keeps all impurities from contaminating the towers and allow you to regulate your outlet pressure.</p>	<p>HR1-4 HR5-7</p>	<p>AD21-HR14-R AD21-HR57-R</p>
	<p>Filter Element Kit Replacement elements for a 5.0 micron coalescing pre-filter, 0.01 micron coalescing pre-filter, and 1.0 micron after filter.</p>	<p>HR1-4 HR5-7</p>	<p>ED21-HR14 ED21-HR57</p>

10.4 Accessories for Your Air Dryer Continued

	Description	Model Number	Part Number
	<p>Moisture Indicator Kit Brass fittings and a nickel-plated steel blue to pink indicator on a brass tee.</p>	<p>HR1-4 HR5-7</p>	<p>20503 30803</p>
	<p>Humidity Alarm Kit An electronic device that is installed downstream to monitor humidity.</p>	<p>3% 10%</p>	<p>20506-R3 20506-R</p>

10.5 Tower Disassembly/Reassembly (See section 10.1 diagram)

It may be necessary to disassemble/reassemble the dryer when replacing the desiccant tower(s). Altec AIR provides this service; however, if inclined it may be done by a technician. Contact Altec AIR technical support prior to any servicing for technical instructions.

	Description	Model Number	Notes
Hardware	If equipped with nylock nuts, it is recommended to replace with non-locking hex nuts.	HR1-4 HR5-7	100519644 100519645
Threadlocker	When reassembling dryer, apply Loctite to threads.	HR1-4 HR5-7	Loctite 243
Torque Specifications	When reassembling the dryer, the hex nut(s) need to be accurately torqued.	HR1-4 HR5-7	10.5 FT. LBS 19 FT. LBS

*Older units will utilize 2 (two) nylock nuts and a 1 (one) kep nut to secure assembly. Newer units utilized a welded nut on the end of the threaded rod and one (1) hex nut with Loctite. Altec AIR **recommends** replacing nylock nuts with non-locking hex nuts with Loctite.

10.6 Ordering Parts from Altec AIR



IMPORTANT!

Instruction for the replacement of individual listed components goes beyond the scope of this User's Guide and will not be covered. Please refer to the information included with the specific replacement part for this instruction.

Once you have identified your required parts and accessories, contact the Altec AIR Inside-Sales department to order:

(800) 521-5351 (**option 2**)

Fax – (303) 657-2205

sales@AltecAIR.com

11. Service & Repair

11.1 Services Offered by the Altec AIR's Facility

- **Complete Dryer Repair**
 - Replace desiccant towers, install viton o-ring kit, change out solenoid assemblies (as required), clean both shuttle discs (replace if necessary), replace purge mufflers, and verify SS timer is working properly.

11.2 Initiating a Service Transaction

- Contact our Parts & Service Department at **1-800-521-5351 (option 3)** to obtain a Return Authorization (RA) number.
- Carefully package the item(s) to be returned.
- Mark the Return Authorization (RA) number on the outside of the shipping container.
- Include the main address and phone number of the individual to contact for related inquiry and follow-up information.
- Include the purchase order number.

12. Troubleshooting Your Air Dryer

12.1 Before You Call Altec AIR

PLEASE READ THIS SECTION FIRST. It is important that you use the following sections in order to diagnose and attempt to fix the problem with your air dryer before placing a call to Altec AIR Technical Support.

This troubleshooting guide is intended to simplify the isolation of problems, present possible causes, provide test procedures for verification, and suggest corrective actions to restore the air dryer back to normal operation. Each section begins with the most likely cause(s) of the issue. Otherwise, they start from the simplest possibilities and progress to more complicated ones.

This troubleshooting guide is designed to be easy to follow and very effective when used properly. It is suggested to always start at the beginning of the specific problem section and continue in sequence, following the procedures indicated.

12.2 Safety & Warning Information



WARNING!

For your safety, all the information in this User's Guide must be followed to minimize the risk of electrical shock and prevent property damage or personal injury.



WARNING!

Extreme care should be exercised to avoid contact with live electrical circuits. Many procedures performed during installation and testing of this air dryer require the equipment to be running, creating a situation for potential electrical shock. It is highly recommended that you remove all jewelry before performing any procedures.



IMPORTANT!

Performing procedures not described in this User's Guide or installing components not supplied by Altec AIR is **NOT RECOMMENDED AND MAY VOID THE WARRANTY.**

12.3 Low Pressure

Possible Cause	Check	Corrective Action
No power to unit	Verify power is supplied to the unit (section 8.3)	Troubleshoot facility power supply to air dryer
Dirty or obstructed inlet filter	Verify inlet air filters elements are clean	Replace filter elements (section 10.3)
Inlet and outlet ports reversed	Verify ports for proper orientation (section 6.6.4)	Reconnect properly

12.4 Excessive Purge

Possible Cause	Check	Corrective Action
Solenoid valve burned out	Test for consistent dryer cycle, and verify voltage (section 8.2 and 8.4)	Replace valve (section 10.2)
Defective cycle timer	Test for consistent voltage to the solenoid valves (section 8.2)	Replace cycle timer (section 10.2)

12.5 Delivers Wet Air

Possible Cause	Check	Corrective Action
High inlet temperature	Verify inlet temperature is below 100°F	Reduce inlet air temperature
Air flow through dryer in excess of rated capacity	Verify outlet flow does not exceed air dryer's rated flow	Reduce air usage downstream
Low inlet pressure	Verify inlet pressure meets air dryer's rated pressure or is not restricted. (section 12.3)	Increase pressure, or replace filter elements (section 10.3)
Purge orifice plugged	Verify the orifice is free from debris and is in good working condition.	Clean and/or Replace orifice (section 10.3)
Solenoid valve burned out	Listen for proper purge cycle, and verify voltage (section 8.2 and 8.4)	Replace valve (section 10.3)

Contamination of desiccant	Remove in and outlet connections and look for white powder	If white powder is present replace towers (section 10.1)
Defective timer	Verify timing cycle (section 8.3)	Replace timer (section 10.2)
Purge flow restricted		Replace purge mufflers (section 10.2)

12.6 Contacting Altec AIR Technical Support

Please read the *Before You Call Altec AIR* section (12.1)

Once you have exhausted all of the potential problems and solutions covered in the *Troubleshooting Your Dryer* section, and you still require further assistance to correct a problem, contact Altec AIR Technical Support:

(800) 521-5351 (option 1)

Have the following information available:

Trouble Ticket # (if following-up on a previous call): _____

Technician Name: _____ **Phone #:** _____

Model #: _____ **Serial #:** _____

Company Name: _____ **Location Name:** _____

City: _____ **State:** _____

13. Appendix

13.1 Model Number Coding

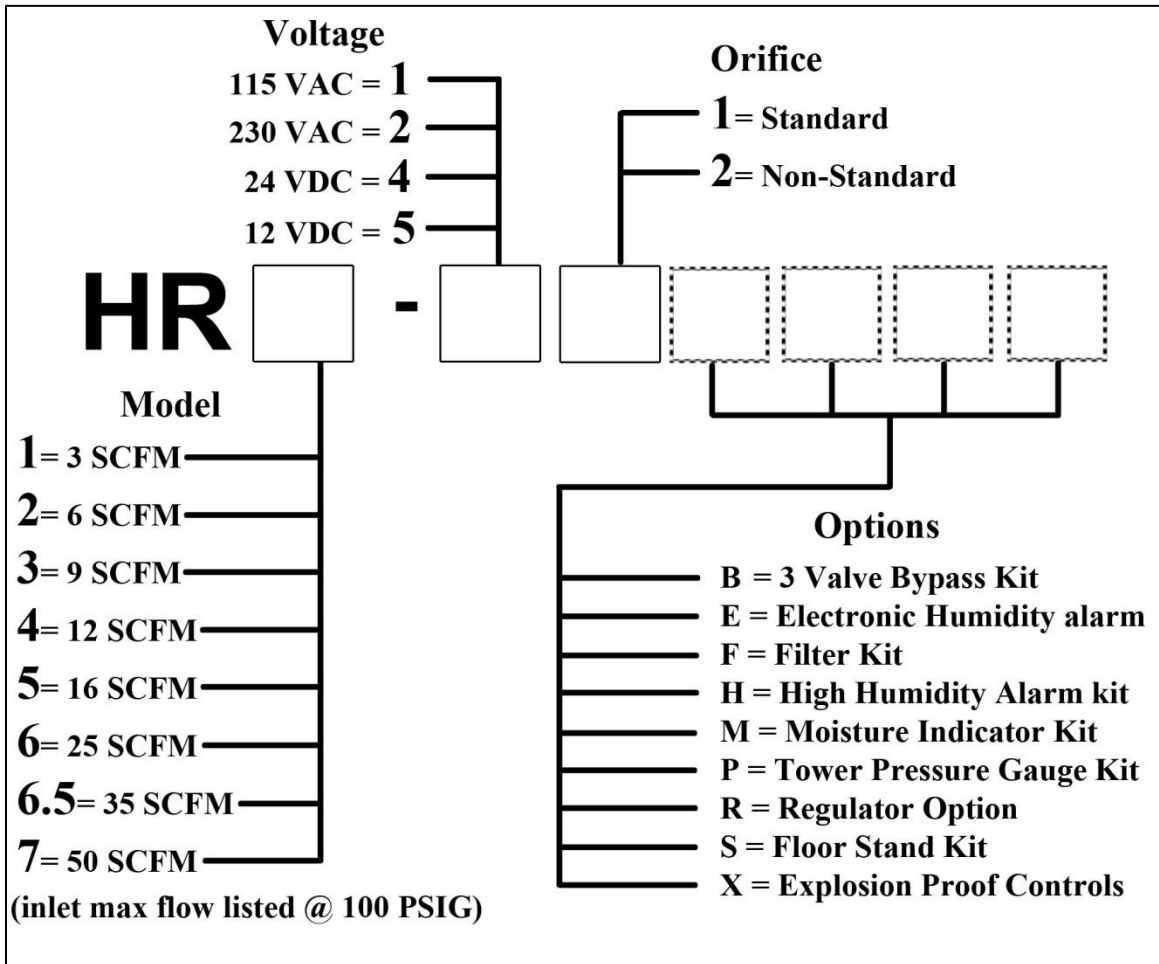

13.2 Wiring Diagram

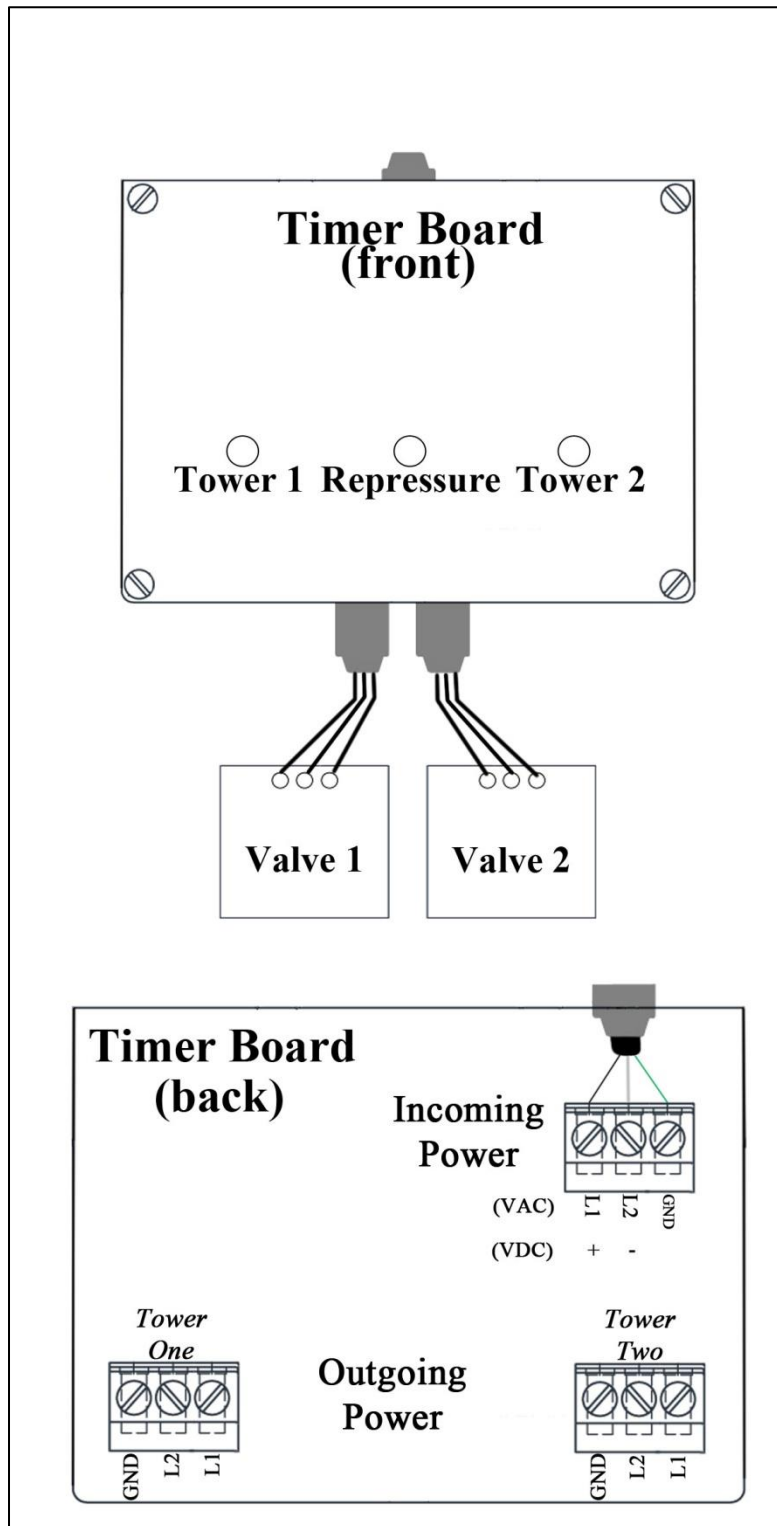

14. Limited Warranty Agreement

Altec AIR products carry a one (1) year warranty against defective workmanship and material. This period starts at date of shipment. Not included are the components subject to normal replacement during a year's operating time.

No claims for labor in replacing defective parts or for consequential damages will be allowed. Replacement parts will be invoiced in the regular way, with invoices subject to adjustment after the parts claimed defective are examined at our factory. In addition, no material or parts will be accepted at our factory for in-warranty repairs or credit without previous authorization from Altec AIR.

Responsibility for damages incurred in transit will be borne by the user and the user in turn should file any damage claim against the carrier. All warranty items are F.O.B. Broomfield, Colorado. Freight charges are the responsibility of the user.

This warranty shall not apply to any Altec AIR product which shall have been repaired or altered in any way by anyone other than Altec AIR or authorized personnel so as to affect, in our judgment, its proper functioning or reliability, neither will it apply to any product which has been subject to misuse, negligence, or accident. The installation of unauthorized non Altec AIR parts will void the warranty on those Altec AIR products.

Registration Reminder

If you haven't already done so, please take a moment to register your Altec AIR HR SERIES AIR DRYER. **Registering is necessary to activate this Limited Warranty on your product.** Once you register, you are eligible to receive free technical support, as well as updates concerning your Altec AIR products.

See Section 7. for details on Registering Your Air Dryer.

15. Contacting Altec AIR

15.1 General

Altec AIR, LLC
226A Commerce Street
Broomfield, Colorado 80020

(800) 521-5351

(303) 427-3700

Fax – (303) 657-2233

info@AltecAIR.com

www.AltecAIR.com

15.2 Sales

(800) 521-5351 (**option 2**)

Fax – (303) 657-2205

sales@AltecAIR.com

15.3 Service

(800) 521-5351 (**option 3**)

Fax – (303) 657-2205

15.4 Technical Support

(800) 521-5351 (**option 1**)

DON'T FORGET TO REGISTER YOUR HR AIR DRYER!

See Section 7. for details on Registering Your Air Dryer.

16. Maintenance Log Sheet

MODEL: _____

LOCATION NAME: _____

SERIAL NUMBER: _____

ADDRESS: _____

DATE INSTALLED: _____

Procedure	Section	Maintenance Interval (Months)				
		6	12	18	24	30
Visually Inspect HR for Loose Wiring or Hardware	6.6.2	<input type="checkbox"/>	<input type="checkbox"/>	<input type="checkbox"/>	<input type="checkbox"/>	<input type="checkbox"/>
Test Consistent Dryer Cycling	8.2	<input type="checkbox"/>	<input type="checkbox"/>	<input type="checkbox"/>	<input type="checkbox"/>	<input type="checkbox"/>
Visually Verify Cycle Timer has Voltage	8.3	<input type="checkbox"/>	<input type="checkbox"/>	<input type="checkbox"/>	<input type="checkbox"/>	<input type="checkbox"/>
Replace Purge Mufflers	10.2		<input type="checkbox"/>		<input type="checkbox"/>	
Replace Filter Elements (If installed)	10.3		<input type="checkbox"/>		<input type="checkbox"/>	
Maintenance Performed by:						
Date of Maintenance:						

NOTE: COPY OR PRINT THIS PAGE AND KEEP IT WITH THE AIR DRYER

17. Notes
